

(NOTE: DESIGNER LOCKER SHOWN WITHOUT SIDE PANEL OR SLOPING HOOD. PLEASE ORDER SEPARATELY.)

MODEL #37158
DOUBLE TIER 'S' STYLE
DESIGNER LOCKER - 1 WIDE

(2) LOCKER COMPARTMENTS
EACH COMPARTMENT:
10 3/4" W x 34 3/4" H x 16 3/4" D

SIDE VIEW

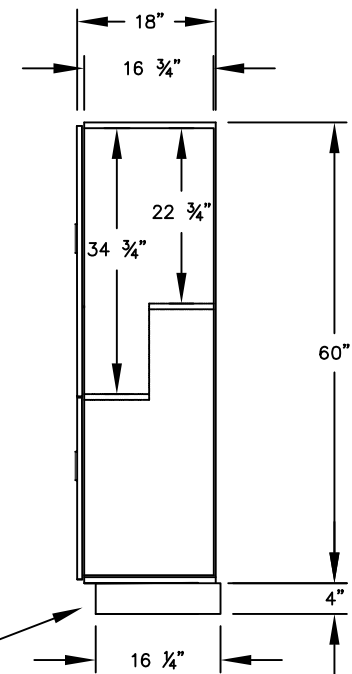

(BASES ARE MADE OF INDUSTRIAL GRADE PARTICLEBOARD AND ARE COVERED IN A DURABLE BLACK LAMINATE. PLEASE SET BASE TO ALLOW 5/8" BETWEEN THE BACK OF THE LOCKER AND THE WALL FOR AIR VENTILATION.)

MODEL #37158

12" WIDE DOUBLE TIER 'S' STYLE
DESIGNER WOOD LOCKER
FIVE FEET HIGH (ADD 4" FOR BASE)

AVAILABLE FINISHES: GRAY, BLUE, BLACK,
MAPLE, CHERRY OR MAHOGANY

DRAWN: 07/18

Established in 1936, Salsbury Industries is the industry leader in manufacturing and distributing quality lockers.

1010 E. 62ND STREET
LOS ANGELES, CA 90001
PHONE: (800) 562-5377
FAX: (800) 562-5399
email: engineering@lockers.com