

(NOTE: DESIGNER LOCKER SHOWN WITHOUT SIDE PANEL OR SLOPING HOOD. PLEASE ORDER SEPARATELY.)

MODEL #32151  
DOUBLE TIER  
DESIGNER LOCKER - 1 WIDE

(2) LOCKER COMPARTMENTS  
EACH COMPARTMENT:  
10 3/4" W x 28 3/4" H x 19 3/4" D

SIDE VIEW

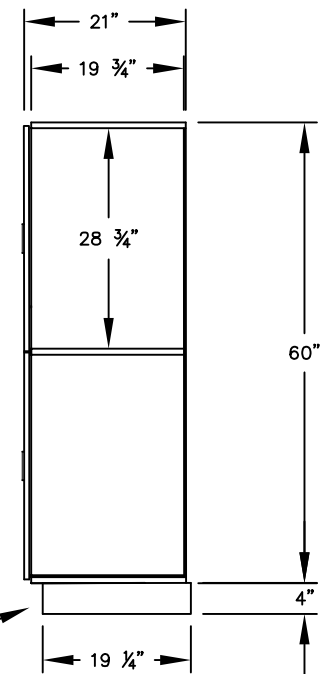

(BASES ARE MADE OF INDUSTRIAL GRADE PARTICLEBOARD AND ARE COVERED IN A DURABLE BLACK LAMINATE. PLEASE SET BASE TO ALLOW 5/8" BETWEEN THE BACK OF THE LOCKER AND THE WALL FOR AIR VENTILATION.)

MODEL #32151

12" WIDE DOUBLE TIER  
DESIGNER WOOD LOCKER  
FIVE FEET HIGH (ADD 4" FOR BASE)

AVAILABLE FINISHES: GRAY, BLUE, BLACK,  
MAPLE, CHERRY OR MAHOGANY

DRAWN: 07/18

***Established in 1936, Salsbury Industries is the industry leader in manufacturing and distributing quality lockers.***

1010 E. 62ND STREET  
LOS ANGELES, CA 90001  
PHONE: (800) 562-5377  
FAX: (800) 562-5399  
email: [engineering@lockers.com](mailto:engineering@lockers.com)